

Product Specification

Product Class: LED Lens

Item No: **DK-5050-60-LENS-4H1-H8.5-XPE**

Material: PMMA

Certification: RoHS

Sut Up:Xuan Yang

Check:Xiaohui Liang

Content

Specification-----	3
2D Drawing-----	4
Optical Datasheet-----	5
Packing-----	6
Application Notes-----	7

Specification

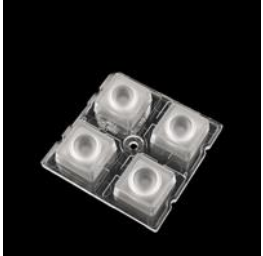
Item No	Picture	Size	Matched LED	Lighting Application
DK-5050-60-LENS-4H1-H8.5-XPE		diamete: 49.89*49.89mm height:8.49mm FWHM: 60°	3535	LED High Bay Light

Drawing

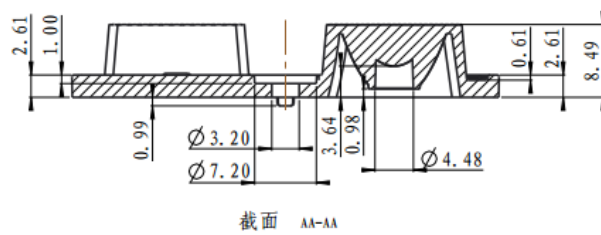
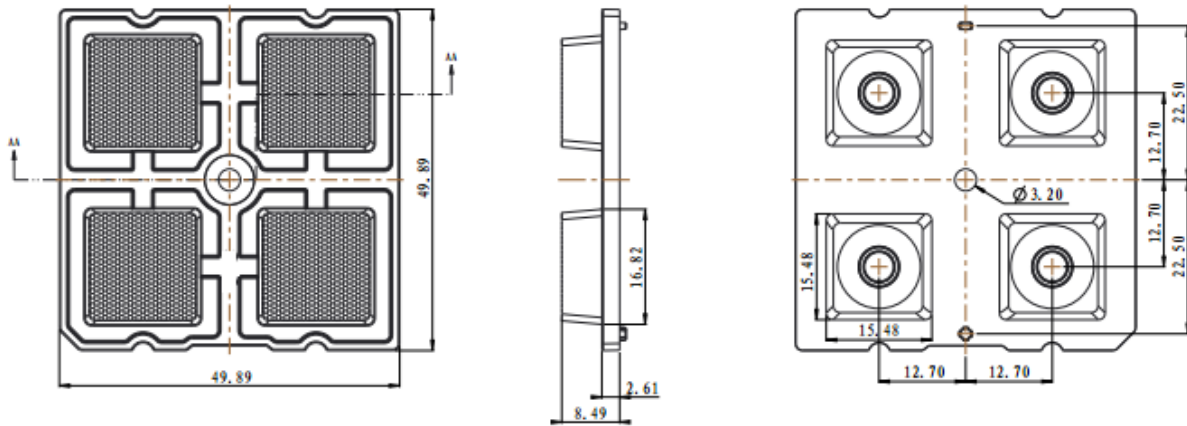

Optical Test Report

产品特征

灯具种类:

电压: 0.0 V

功率: 0.00 W

电流: 0.000 A

功率因数: 0.000

光度结果

灯具CIE分类: 直接型

灯具光通量: 143.2 lm

下射光通量比: 100%

水平扩散角(25%, 50%, 75%, 100%): H81.3, H61.3, H42.5, H5

垂直扩散角(25%, 50%, 75%, 100%): V81.4, V61.2, V42, V10

灯具光效等级(LER): 143

峰值光强: 125.38 cd

额定光通量: 143.2 lm

灯具效率: 100%

上射光通量比: 0%

中心光强: 116.18 cd

峰值光强位置: H90 V10

灯具实物照片



配光曲线

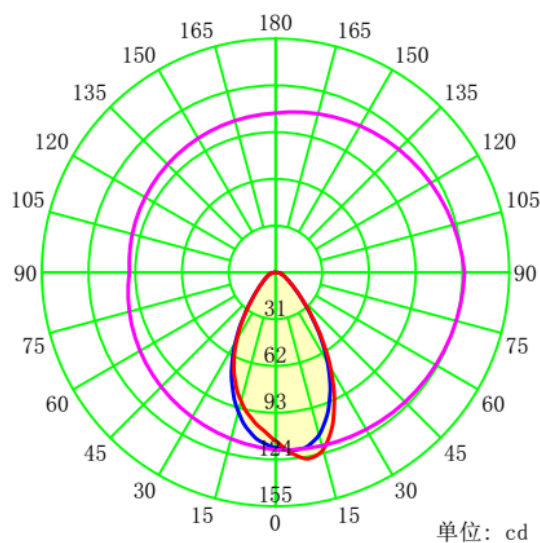

平均光束角(50%): 61.2°

配光曲线

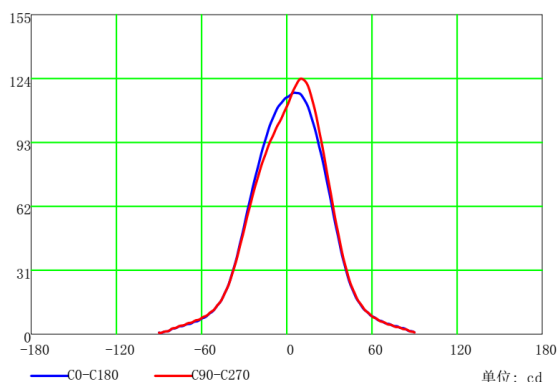
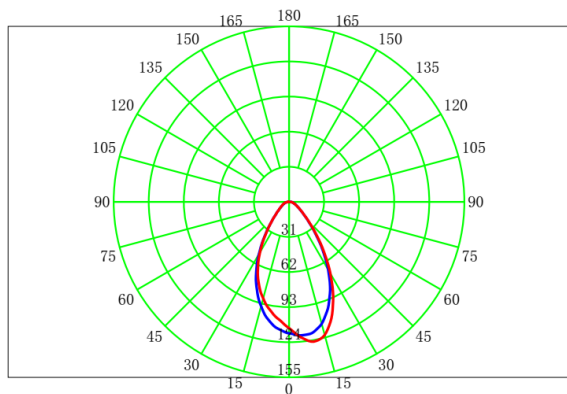

Packing

Material	Size	Total
Antistatic blister box	4W	20PCS a layer or deck
Box	335*245*105mm	220PCS/ Box
Outer Box	510*330*255mm	880pcs/ Outer Box

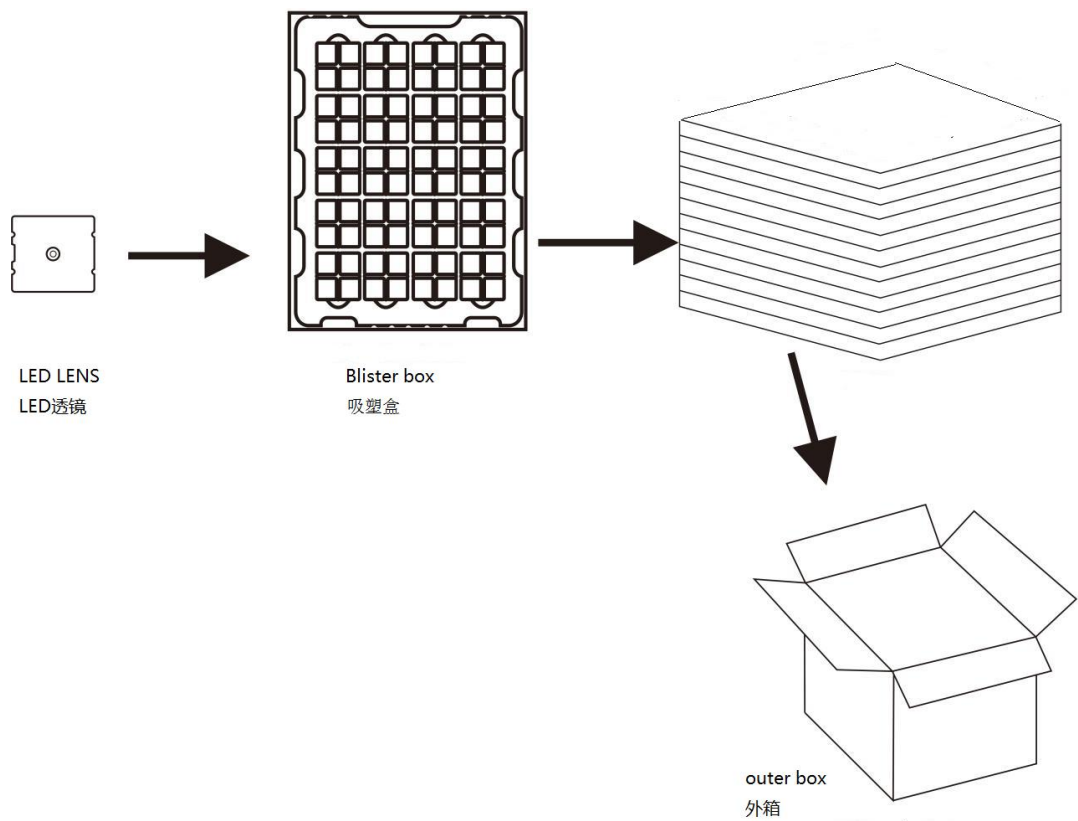

Application Notes

(1) Please use a little water and soft fabric (air-laid paper) to clean the lens & reflector if necessary.

(2) Forbid to use industrial solvent to clean the lens, such as alcohol.

(3) The working temperature is $-40^{\circ}\text{C}\sim+80$.

(4) Storage environment temperature is $0^{\circ}\text{C}\sim40^{\circ}\text{C}$, humidity is 30%~95%.

Optic Lens has the function to change the ray of light, it is made of optical material, the effect shall be influenced once pollute. Please do not open the packing before use it, to avoid the dust pollution.

(5) Protect the product from the sun and other ultraviolet ray, as these will lead to aging, change color, crack, etc.

(6) Please wear gloves once install the lens, avoid to abrasion the lens surface.

(7) Forbid to use acidic or alkaline solution touch the product, avoid to generate the chemical reactions.